

# Behavioral and neural effects of chromatic isoluminance in the primate visual motion system

KAREN R. DOBKINS AND THOMAS D. ALBRIGHT

Vision Center Laboratory, The Salk Institute for Biological Studies, La Jolla

(RECEIVED June 6, 1994; ACCEPTED September 12, 1994)

## Abstract

We have previously reported that the responses of individual neurons in macaque visual area MT elicited by movement of contrast-reversing heterochromatic red/green borders are largest when the two hues are “balanced” or isoluminant (Dobkins & Albright, 1994). This “neural” isoluminant point was found to vary somewhat across the sample of neurons. Here, we compare the average neural isoluminant point in area MT to a behavioral measure of isoluminance, obtained using a modification of an oculomotor procedure developed by Chaudhuri and Albright (1992). These behavioral estimates of isoluminance closely parallel the neuronal data obtained from area MT. In accordance with previous evidence (e.g. Lee et al., 1988; Kaiser et al., 1990; Valberg et al., 1992), this correlation suggests that activity within the dorsal/magnocellular stream underlies behavioral expression of chromatic isoluminance.

**Keywords:** Neurophysiology, Extrastriate area MT, Neural isoluminance, Behavioral isoluminance, Oculomotor responses

## Introduction

A variety of psychophysical techniques have been employed to study the relative sensitivity of the human visual system to different wavelengths of light. The accumulative results from these *photometric* measures, which involve matching the brightness of two hues, have generated what is referred to as the C.I.E. spectral luminous efficiency function, or  $V\lambda$  function (for review, see Pokorny & Smith, 1986). As a means of elucidating the neural basis for the perceptual brightness matches made by human observers, recent neurophysiological experiments have explored the response properties of neurons in the visual system of macaque monkeys. For example, the neural basis for *heterochromatic flicker photometry* (HFP), a technique that has provided the majority of the data used to derive the human  $V\lambda$  function, has been explored through neurophysiological recordings in the macaque retina (Lee et al., 1988). HFP consists of adjusting the relative intensities of two temporally alternating hues until they “fuse,” or the sensation of flicker is minimal. At the point of fusion, the two hues are considered to be isoluminant. To investigate the neural basis of this phenomenon, Lee et al. measured responses of phasic (M, magnocellular) and tonic (P, parvocellular) retinal ganglion cells elicited by flickering heterochromatic stimuli. Responses were assessed for a range of relative intensities of the two hues. The responses of phasic, but

not tonic, cells went through a minimum at relative intensities similar to that predicted from the  $V\lambda$  function, suggesting a magnocellular basis for the perception of heterochromatic flicker fusion.

Providing further evidence along these lines, Kaiser et al. (1990) and Valberg et al., (1992) demonstrated that activity within phasic retinal ganglion cells provides the physiological basis for another photometric method, the *minimally distinct border* technique. This technique involves setting the relative intensities of two spatially juxtaposed and differently colored fields until the border between them is minimally distinct. When phasic cells are presented with such patterns of varying hue intensities, they exhibit a response minimum near human  $V\lambda$  isoluminance, thus mirroring the perceptual phenomenon.

Neurophysiological experiments conducted in the magnocellular (or “dorsal”) divisions of visual cortex of macaque monkeys have also revealed correlates of perceptual phenomena that occur at isoluminance. For example, psychophysical experiments in human subjects have demonstrated that motion perception is impoverished at isoluminance (e.g. Ramachandran & Gregory, 1978; Cavanagh et al., 1984; Livingstone & Hubel, 1987; Teller & Lindsey, 1993). In harmony with this psychophysical phenomenon, directionally selective neurons in layer 4B of striate cortex exhibit response minima for moving red/green stimuli when the luminance ratio of the two hues approximates human  $V\lambda$  isoluminance (Hubel & Livingstone, 1990). Other relevant neurophysiological studies have focused on the responses of directionally selective neurons in the middle temporal area (MT), an area of primate visual cortex recognized as a key component of the neural substrate for motion perception

Reprint requests to: Thomas D. Albright, Vision Center Laboratory, The Salk Institute, P.O. Box 85800, San Diego, CA 92186, USA.

Correspondence to: Karen R. Dobkins, Psychology Department NI-25, University of Washington, Seattle, WA 98195, USA.

(e.g. Zeki, 1974; Maunsell & Van Essen, 1983a; Albright, 1984). When presented with moving red/green patterns, MT neurons frequently exhibit response minima when luminance ratios are near V $\lambda$  isoluminance (Saito et al., 1989; Charles & Logothetis, 1989; Gegenfurtner et al., 1994; Dobkins & Albright, 1990, 1994).

In sum, the accumulative data imply a strong association between neural activity in the magnocellular/dorsal stream and perceptual phenomena at chromatic isoluminance. It is important to recognize, however, that chromatic isoluminance defined from the human V $\lambda$  function (i.e. *photometric* isoluminance) is derived from an average across a large number of human psychophysical observers. This average represents the human luminosity function for the *standard* observer, with individual differences existing across subjects. In other words, the relative brightnesses of two hues matched for one observer may not agree with the relative brightnesses of those hues matched for another observer.

Due to this variation across subjects, psychophysical methods have been developed in order to obtain precise estimates of chromatic isoluminance for individual human (e.g. Anstis & Cavanagh, 1983; Cavanagh et al., 1987; Livingstone & Hubel, 1987; Chaudhuri & Albright, 1992) and non-human primate (DeValois et al., 1974; Schiller et al., 1990; Logothetis et al., 1990; Logothetis & Charles, 1990; Chaudhuri & Albright, 1992) subjects. As would be expected from the original body of work comprising the V $\lambda$  function, individual differences have been observed. Furthermore, even within an individual, isoluminance estimates have been shown to depend on method of measurement (Wagner & Boynton, 1972; Livingstone & Hubel, 1987; Webster & Mollon, 1993), and on stimulus parameters such as spatial frequency (Mullen, 1985; Cavanagh et al., 1987; Logothetis & Charles, 1990) and temporal frequency (Kelly, 1983; Cushman & Levinson, 1983; Cavanagh et al., 1987; Livingstone & Hubel, 1987; Pokorny et al., 1989; Dobkins & Albright, 1993). Such variation suggests that psychophysically determined isoluminance is not a unique phenomenon.

In light of the known variability in perceptual isoluminance across individuals, method of measurement, and stimulus parameters, we believe that the association between neural and behavioral effects of chromatic isoluminance would be more convincing if both measures were collected from the same animal, under the same stimulus conditions. To address this issue directly, we have compared neural and behavioral measures of isoluminance within individual monkeys. Our neural measure consisted of responses from individual neurons in area MT. These neurophysiological results have been described in detail in a previous report (Dobkins & Albright, 1994). Our behavioral measure consisted of involuntary tracking eye movements elicited under conditions similar to those employed in our neurophysiological studies. The advantages of using this eye movement technique for our behavioral measure are two-fold; first, it requires no training of the monkey; and second, previous experiments have demonstrated that this technique yields estimates of isoluminance that are identical to those obtained from perceptual reports (Chaudhuri & Albright, 1992).

The results of these experiments demonstrate that neural and behavioral estimates of isoluminance within individual subjects correlate extremely well. This finding suggests that activity within area MT is closely associated with the behavioral expression of chromatic isoluminance.

## Method

### Apparatus

All visual stimuli were generated using a high-resolution, high-speed computer video display and digital frame buffer (Pepper SGT, Number Nine Computer Corp: 640  $\times$  480 pixels, analog RGB output, 8 bits/gun). The controller resided in an AT-class (80386) personal computer and it permitted 256 simultaneously displayable colors or luminance levels (selected from a palette of 16 million). Stimuli were displayed on a 20-inch analog RGB video monitor (Phillips C2064-AS, 60 Hz, noninterlaced). The voltage/luminance relationship was linearized independently for each of the three guns in the display (Watson et al., 1986). For both our neurophysiological and behavioral experiments, stimulus generation operated under the charge of a PDP 11/73, which provided coded instructions for selection and timing of visual stimuli produced by the graphics device. The PDP 11/73 was also used for data acquisition, analysis, and behavioral control.

### Animal preparation

#### Subjects

Three adult female rhesus monkeys (*Macaca mulatta*) were used for our neurophysiological study and two of these monkeys were used for the oculomotor study. The protocols used in these experiments have been approved by the Salk Institute Animal Care and Use Committee and they conform to USDA regulations and NIH guidelines for the humane care and use of laboratory animals.

#### Surgical preparation

Monkeys were surgically prepared for training and physiological recording using conventional techniques. These procedures have been described previously in detail (Dobkins & Albright, 1994). Briefly, two stainless-steel recording cylinders and a post for head restraint were affixed to the skull with dental acrylic and stainless-steel screws. Cylinders were positioned bilaterally over parietal lobe regions (centered at approximately AP: -4 mm, ML: 17 mm). A search coil for measuring eye position (Cooner Wire Co., Chatsworth, CA) was surgically implanted in one eye using the method of Judge et al. (1980). The leads of the coil were soldered to a 2-pin mini connector (Hamilton Avnet, San Diego, CA) and affixed to the cranial implant with dental acrylic. A week before the first neurophysiological recording session, one of the recording cylinders was opened and an 8-mm-diameter hole was drilled through the skull to allow electrode passage into area MT.

#### Behavioral training

Animals were trained to fixate a small (0.3-deg diameter) spot of light on the video display in the presence of moving visual stimuli for the duration of a trial (up to 3 s). Head movements were prevented by bolting the implanted head-post to the frame of the primate chair. Performance on the fixation task was monitored by continuously recording eye position using the magnetic search coil technique (Robinson, 1963). Upon successful completion of a trial animals were given a small (approximately 0.15 ml) juice reward. Once each animal reached a criterion level of performance (95% correct) on this task, experiments were begun.

### Visual stimulation

#### Cone photoreceptor activation

Chromatic stimuli were produced by differential modulation of only the monitor's red and green phosphors (C.I.E. coordinates: red = 0.618, 0.350; green = 0.208, 0.605). The relative activations of the cone photoreceptors produced by these phosphors are illustrated in Fig. 1 (MacLeod & Boynton, 1979). Our calculations indicate that differential modulation of the red and green phosphors of our monitor caused negligible differential activation of S cone photoreceptors but provided 20% differential activation of L and M cones. Individual cone contrasts for L and M cones were determined to be 14% and 34%, respectively.

#### Construction of heterochromatic gratings

Heterochromatic red/green gratings were produced by summing sinusoidal luminance modulations of the red and green phosphors, of identical spatial frequency and orientation but of opposite phase. The luminance contrast of the resultant heterochromatic stimulus is dependent upon the mean luminances and relative amplitudes (modulation depths) of the composite mono-phosphor sinusoids (Fig. 2). Luminance contrast was varied by differentially adjusting the mean luminances of the red and green sinusoids such that the mean luminance of the het-

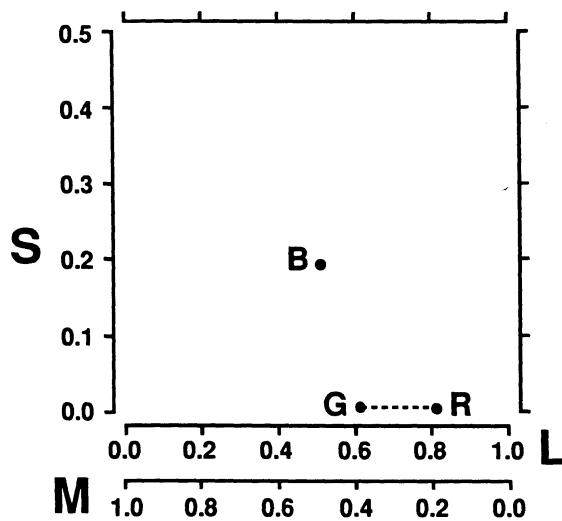

Fig. 1. MacLeod-Boynton chromaticity diagram (MacLeod & Boynton, 1979) showing relative cone activations caused by isoluminant settings of the three phosphors in our video display (filled circles). Cone activations were computed by, first, integrating the spectral radiance distribution for each phosphor with the spectra  $x$ ,  $y$ , and  $z$ . The resultant tri-stimulus values were then employed to calculate cone activations using functions provided by Boynton (1986) based upon Smith-Pokorny cone action spectra (Smith & Pokorny, 1972, 1975). Our calculations indicate that the red (R) and green (G) phosphors of our monitor provide 20% differential activation of long-wavelength-sensitive (L) and medium-wavelength-sensitive (M) cones. Cone contrasts for L and M cones were determined to be 14% and 34%, respectively. Chromatic modulation along the horizontal axis in this space brings about no change in the excitation of short-wavelength-sensitive (S) cones while causing the signals in the L and M cones to covary, so as to keep their sum constant. Conveniently, the R and G phosphors fall very near horizontal, causing negligible differential activation of S cones.

erochromatic stimulus was held constant at  $8.1 \text{ cd/m}^2$ . For neurophysiological experiments in one monkey (Lefty), a slightly different procedure was used to vary luminance contrast level: the red mean luminance was held constant while the green mean luminance varied. For experiments conducted in this monkey, therefore, luminance of the heterochromatic grating covaried with the mean luminance of the green phosphor and ranged from  $5.3$  to  $11.2 \text{ cd/m}^2$ . Modulation depth ( $MD$ ), defined as the amplitude of the red and green sinusoids expressed as a percentage of their respective means, was held constant at 90%. Luminance contrast (Michelson) in the heterochromatic stimulus is expressed as  $MD * [(G_{\text{mean}} - R_{\text{mean}}) / (G_{\text{mean}} + R_{\text{mean}})]$ .

The spatial frequency of the heterochromatic stimulus was set at 0.49 cycle/deg. At this low spatial frequency, the maximum luminance contrast introduced by chromatic aberration is minimal ( $<0.5\%$  for maximum 4-mm pupil, Flitcroft, 1989; Cavanagh & Anstis, 1991; Dobkins & Albright, 1994). Potential aberration-induced luminance contrast is therefore below psychophysical detection threshold (Robson, 1966; Logothetis et al., 1990; Cavanagh & Anstis, 1991) and below the sensitivity of MT neurons (Saito et al., 1989; Sclar et al., 1990; Dobkins & Albright, 1994).

#### Movement of heterochromatic stimuli

Moving stimuli were of the "apparent motion" type, i.e. gratings were displaced by discrete spatial and temporal intervals, both within a range that normally renders a clear percept of motion (Kolers, 1972) and elicits responses in MT neurons (Mikami et al., 1986; Newsome et al., 1986). Movement was achieved by spatial phase offset at regular intervals occurring in synchrony with the vertical refresh of the video monitor (i.e. at multiples of 16.67 ms). For these experiments, spatial phase offset was coincident with every other vertical refresh (i.e. every 33.33 ms, or 30 frames/s).

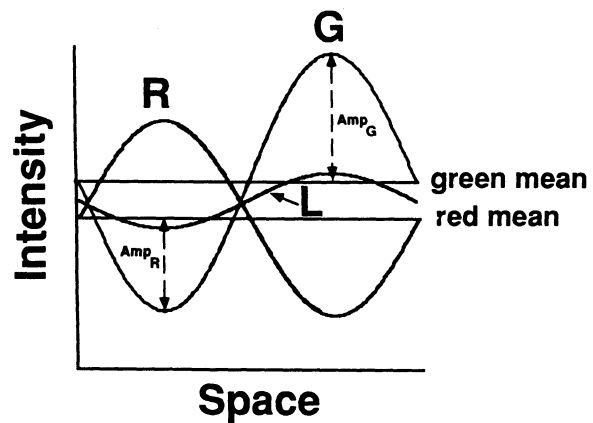

Fig. 2. Construction of heterochromatic (red/green) gratings. The luminance contrast level is varied by differentially adjusting the mean luminances of the red and green luminance profiles. Amplitude-modulation depth ( $MD$ ), defined as the amplitude of the red and green sinusoids expressed as a percentage of their respective means, is held constant. Luminance contrast (%) =  $MD * [(G_{\text{mean}} - R_{\text{mean}}) / (G_{\text{mean}} + R_{\text{mean}})]$ . Using this metric, luminance contrast can be either positive or negative, depending upon which of the two phosphor primaries is brighter. In this example, the mean luminance of the green (G) is greater than the red (R) and the resulting R/G luminance modulation (L) is shown.

## Neurophysiological experiments

### Visual stimulus

The stimulus used in these experiments consisted of a heterochromatic red/green grating that underwent contrast reversal coincident with each spatial displacement. The spatio-temporal profile of this stimulus is illustrated in Fig. 3A. With each spatial displacement, chromatic contrast is inverted (red becomes green, green becomes red, etc.). Under these conditions there are two opposing cues for motion correspondence. The first is a contrast-reversing (*unsigned*) chromatically defined contour (moving upward in Fig. 3A), which is the most proximal cue for motion correspondence. The second is invariant (*signed*) chromatic contrast (moving downward in Fig. 3A). When human subjects view this heterochromatic stimulus, motion of the contrast-reversing border (solid arrow, Fig. 3A) is most salient when the red/green luminance ratio is near photometric isoluminance (Dobkins & Albright, 1993). Away from isoluminance, subjects report seeing motion in the direction that preserves the sign of both chromatic and luminance contrast (dashed arrow, Fig. 3A). Mirroring the perceptual effects, responses of macaque area MT neurons elicited by movement of the unsigned contrast-reversing border cue are largest near photometric isoluminance. By contrast, when luminance contrast is added to the heterochromatic stimulus, MT neurons respond best to motion of the signed cue (Dobkins & Albright, 1994).

The size of spatial offset for the unsigned border cue ( $\Delta x$ , Fig. 3A) varied somewhat from neuron to neuron, between 10- and 30-deg phase angle (0.057 deg to 0.17 deg of visual angle, moving at speeds of 1.7 deg/s to 5.1 deg/s, respectively). We chose to use these relatively small phase shifts because, in human psychophysical experiments, we have previously found them to produce a strong percept of motion in the unsigned direction at isoluminance (Dobkins & Albright, 1993). On average, the phase shifts employed were 12.3 deg (Frisbee), 15.9 deg (Tutu), and 22.9 deg (Lefty).

The temporal frequencies (cycles/s, or Hz) produced by these phase shifts is somewhat ambiguous (and potentially confusing) since the contrast-reversed stimulus contains two motion correspondence cues moving in opposite directions, at different spatial offsets. For example, if the unsigned border cue is phase-shifted 10 deg, the signed border cue is phase shifted 170 deg in the opposite direction. If we clock the unsigned chromatic border, we would say that it moves at 0.83 Hz. Alternatively, if we clock the signed chromatic border, we would say that it moves at 14.2 Hz. Since cells at early stages of visual processing signal light exchange in their receptive fields, we feel that it is more appropriate to refer to temporal frequency of red/green light exchange in a given region of the visual field. This occurs at 14.2–12.5 Hz (depending upon the magnitude of phase offset) for the contrast-reversing stimulus in our study. On average, the temporal frequencies employed were 14.0 Hz (Frisbee), 13.7 Hz (Tutu), and 13.1 Hz (Lefty).

To assure that each neuron tested was presented with at least one red/green pair for which the two colors provided equally strong (or "balanced") inputs to the neuron, we employed a luminance bracketing procedure, in which we varied the relative luminances of the red and green phases of our heterochromatic gratings around the  $V\lambda$  photometric isoluminant point. Red/green luminance contrast level was thus varied across eight different levels ranging in equal intervals (5.44%) from -24.2% (red brightest) to +13.9% (green brightest). For neurophysio-

logical experiments in one monkey (Lefty), the size of the luminance contrast interval varied somewhat (minimum interval = 6.2%, maximum interval = 16.6%) and luminance contrast ranged from -54.9% to +20.5%.

### A) MT Stimulus

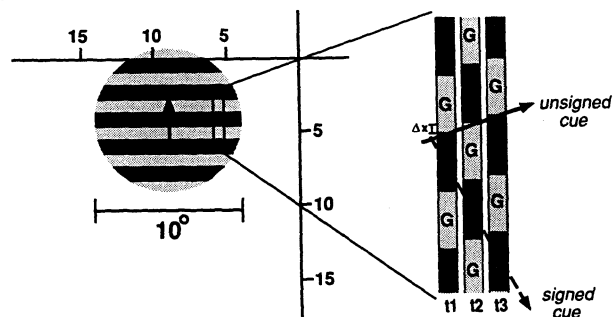

### B) Eye Movement Stimulus

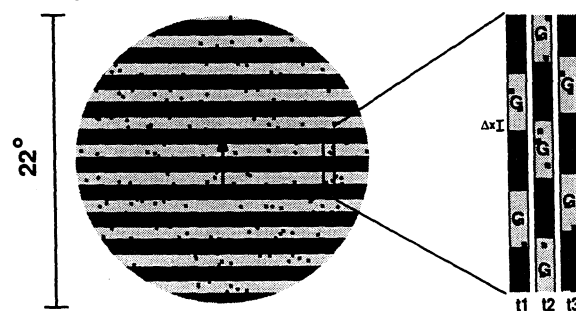

**Fig. 3.** A: Schematic depiction of heterochromatic stimulus used to obtain isoluminant points for individual MT neurons (Dobkins & Albright, 1994). Actual stimuli were red/green (R/G) sine-wave gratings (0.49 cycle/deg) that subtended 10 deg of visual angle. The heterochromatic stimulus underwent reversal of the sign of chromatic contrast coincident with each spatial displacement ( $\Delta x = 10$  deg to 30 deg spatial phase offset, depending on the neuron). Three temporal frames ( $t_1$ ,  $t_2$ ,  $t_3$ ) are shown in an enlarged section of the stimulus (right). Motion of the proximal "unsigned" chromatically defined boundary is upward (solid arrow) while motion of the "signed" chromatic cue is downward (dashed arrow). B: Schematic depiction of heterochromatic stimulus used to elicit oculomotor responses as a behavioral indicant of isoluminance. The stimulus was identical to the heterochromatic stimulus used in our neurophysiological experiments, save its size, location, and the addition of a sparse random array of upwardly moving small black dots (0.06 deg by 0.06 deg, ~1% density). The stimulus subtended 22 deg of visual angle and was centered at the fovea. The bars of the red/green grating were oriented horizontally, and the proximal unsigned border moved in the same direction (upwards) and speed (5.1 deg/s) as the overlying array of black dots. Spatial offset ( $\Delta x$ ) was set at 30-deg phase angle. With respect to the rate of red/green light exchange in a given region of the visual field, this spatial phase offset produced a temporal frequency of 12.5 Hz, a value very close to the average temporal frequencies employed in our neurophysiological studies (see text). This stimulus is a modification of that developed by Chaudhuri and Albright (1992) and is used to estimate chromatic isoluminance in the following manner: When the red and green phases of the grating are roughly isoluminant, heterochromatic flicker in this display is minimized. Under these conditions, motion of the overlying black dots is revealed and tracking eye movements are elicited. The red/green luminance contrast yielding the largest oculomotor gain is defined as the monkey's behavioral isoluminant point.

### Electrophysiological recordings

Paralyne-coated tungsten microelectrodes with exposed tips of 10  $\mu\text{m}$  or less were used to record extracellular potentials from single isolated neurons. Electrodes were lowered into the brain through a stainless-steel guide-tube by way of a hydraulic micro-drive. Levels of spontaneous activity, receptive-field sizes, position relative to sulci, and proportion of cells highly selective for direction of motion were all criteria used to establish that our recordings were, in fact, from area MT.

Once an MT neuron was isolated, its receptive field was mapped and directional selectivity assessed using a high-contrast luminance-defined bar (85  $\text{cd}/\text{m}^2$  on a background of  $<1$   $\text{cd}/\text{m}^2$ ). Following this preliminary assessment, visual stimuli (10-deg diameter) were centered on the geometric center of the receptive field. Neuronal responses were collected to motion of both the unsigned and signed cue in the neuron's preferred direction at each of eight different red/green luminance contrasts of the heterochromatic stimulus. Stimuli were presented in a pseudorandom sequence for a total of five trials for each stimulus type.

### Data analysis

The measure of response was the mean firing rate averaged over five trials of stimulus presentation. An index of directional selectivity (*DI*) was used to quantify the relative strength of unsigned vs. signed responses for each neuron:  $DI = (U - S) / (U + S)$ , where *U* is the firing rate of the neuron in response to motion of the unsigned cue in its preferred direction and *S* is the firing rate in response to motion of the signed cue in its preferred direction. Using this definition, a positive *DI* indicates that unsigned motion correspondence dominated. Likewise, a negative *DI* indicates that signed motion dominated. As an example, a 2:1 ratio between *U* and *S* responses yields a *DI* of 0.33. Note that *DI*s defined in this manner differ from the more conventional direction index:  $DI = 1 - (NP/P)$ , where *P* is the response to movement of a stimulus in the preferred direction, *NP* is the response to movement in the "nonpreferred" (180 deg opposed) direction, and a 2:1 ratio between *P* and *NP* yields a *DI* of 0.50 (e.g. Maunsell & Van Essen, 1983a; Albright, 1984).

### Eye-movement experiments

#### Visual stimulus

The stimulus used to elicit oculomotor responses was identical to the chromatic contrast-reversed stimuli used in our neurophysiological experiments, save its size, location, and the addition of small black dots (Fig. 3B). The stimulus subtended 22 deg of visual angle and was centered at the fovea. The bars of the red/green grating were oriented horizontally and the unsigned border cue always moved upward. The size of spatial offset ( $\Delta x$ , Fig. 3B) was set at 30-deg phase angle (0.17-deg visual angle). With respect to the rate of red/green light exchange in a given region of the visual field, this spatial phase offset, in combination with the contrast-reversal of the stimulus, produced a temporal frequency of 12.5 Hz. This temporal frequency is nearly identical to those employed in our neurophysiological studies (see above).

Superimposed on this heterochromatic grating was a sparse (~1% density) random array of small black dots (0.06 deg by 0.06 deg), the movement of which was in synchrony with that of the unsigned border cue (i.e. upward). For both monkeys tested (Tutu and Lefty), we varied the red/green lumi-

nance contrast across eight different levels ranging in equal intervals (5.44%) from -24.2% (red brightest) to +13.9% (green brightest).

The principle behind this procedure, which is a modification of that developed by Chaudhuri and Albright (1992), is as follows: When the red and green phases of the grating are approximately isoluminant, heterochromatic flicker (arising from contrast-reversal in this display) is minimized. It is only in the absence of flicker that motion of the overlying black dots is revealed. This motion elicits smooth tracking eye movements. Under non-isoluminant conditions, motion of the black dots is masked by luminance flicker. Consequently, eye movements are of smaller amplitude. The luminance contrast that yields the largest eye-movement amplitude is therefore defined as the monkey's behavioral isoluminant point for this task.

It should be noted that, even in the absence of the black dots, this stimulus is perceived to move in the unsigned direction (i.e. upward) at the point of psychophysical isoluminance (see Dobkins & Albright, 1993), presumably because the motion system uses unsigned chromatic borders as a correspondence cue. By contrast, the stimulus appears "flickery" and moves in the signed direction (i.e. downward) when sufficient luminance contrast is present. As described by Chaudhuri and Albright (1992), the purpose of the random black dots is to enhance the gain of tracking eye movements in the unsigned direction at the point of chromatic isoluminance.

#### Oculomotor recordings

As for the neurophysiological experiments, monkeys sat in a standard primate chair with their head held steadied by a restraining post. The heterochromatic stimulus was viewed through a darkened tunnel (60 cm long  $\times$  23.3 cm diameter) in order to conceal stationary contours that might inhibit eye movements. Each trial began with the onset of a small fixation spot (0.3-deg diameter) in the center of the screen. When the monkey had fixated the spot for 666 ms, the heterochromatic stimulus was presented for a total of 1600 ms. Monkeys were required to maintain fixation for the first 700 ms of stimulus presentation. The fixation spot was then extinguished while the heterochromatic stimulus remained present for another 900 ms. During this latter period of unrestrained fixation, the moving stimulus elicited tracking eye movements. A timeline depicting these events is presented in Fig. 4.

Eye movements were monitored by the technique of magnetic search coil oculography (Robinson, 1963). Eight different luminance contrast levels of the red/green grating were presented in a pseudorandom sequence. For one monkey (Lefty), 25 trials were presented for each luminance contrast tested. For the second monkey (Tutu), who exhibited lower eye-movement gain, 40 trials were presented at each contrast value.

#### Oculomotor data analysis

At the end of the experiment, the direction and gain of the slow phase of eye movements were determined by a computer algorithm program on the PDP 11/73. This measurement was made beginning 334 ms after the offset of the fixation spot, for a 500-ms epoch (see Fig. 4). For each trial, eye-movement gain was determined by dividing the eye-movement speed in the unsigned stimulus cue direction (upward) by the speed of the unsigned cue (5.1 deg/s). Individual eye-movement traces were visually inspected in order to exclude trials that contained saccadic eye movements.

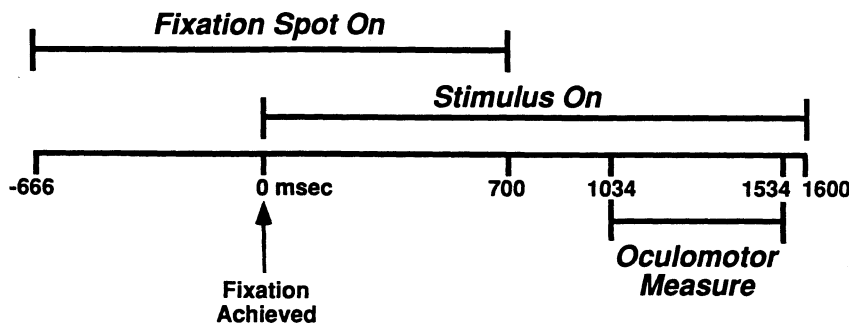

**Fig. 4.** Timeline of events in oculomotor experiments. Each trial began with the onset of a small fixation spot (0.3-deg diameter) in the center of the screen. When the monkey had fixated the spot for 666 ms, the heterochromatic stimulus appeared and remained visible for an additional 1600 ms. The fixation spot was extinguished 700 ms after stimulus onset, at which time the moving stimulus began to elicit tracking eye movements. The direction and gain of these eye movements were evaluated offline beginning 334 ms after the offset of the fixation spot, for a 500-ms epoch.

## Results

### *Directional selectivity in MT neurons as a function of red/green luminance contrast*

The principal result is illustrated for one MT neuron in Fig. 5. This neuron was presented with the contrast-reversed moving heterochromatic stimulus for a total duration of 1.5 s. Cumulative peristimulus histograms obtained in response to movement of the stimulus in the neuron's receptive field are shown below for eight different red/green luminance contrast levels of the heterochromatic grating. Responses are shown for both the unsigned (*U*) and the signed (*S*) cues moving in the neuron's preferred direction. Direction indices (*DI*s), computed from unsigned and signed responses, are plotted as a function of luminance contrast (shown above). By our convention, a positive *DI* indicates that unsigned responses were more robust than signed responses. Conversely, a negative *DI* indicates that signed responses were stronger.

These data illustrate that, for a small range of luminance contrast levels near photometric isoluminance, *DI* was significantly greater than zero, suggesting that unsigned motion correspondence dominated over signed motion correspondence. This indicates that the neuron was able to respond to motion in the direction of the nearest chromatically defined border, despite ongoing contrast reversals at that border. By contrast, when the luminance modulation in the heterochromatic grating exceeded 2.5% or -15%, *DI*s became negative, suggesting that, under these conditions, the neuron was more sensitive to motion of the signed cue. Thus when luminance contrast was sufficiently high, luminance sign (in conjunction with chromatic sign) was a stronger determinant of motion correspondence than unsigned chromatic (and luminance) contrast, despite the fact that proximity favored the latter.

Similar effects were seen for 83/92 (90%) of the neurons in our sample. Each of these neurons exhibited an inverted U-shaped curve similar to that seen in Fig. 5. To obtain a measure of the population response for each animal, we averaged *DI*s across all neurons (Frisbee:  $n = 34$ , Tutu:  $n = 33$ , and Lefty:  $n = 16$ ) for each of the eight luminance contrast levels tested. The results from this manipulation are shown in Fig. 6. As for single neuron data, these population data demonstrate that the largest positive *DI* occurs when the red/green stimulus is close to photometric isoluminance.

### *Determining "Neural" isoluminance*

Because sign of luminance contrast is known to have a large influence on motion correspondence (e.g. Anstis, 1970; Anstis

& Mather, 1985), we expect signed motion correspondence to be strongest (i.e. *DI*s most negative) at luminance extremes and weakest (i.e. *DI*s most positive) when the red and green are balanced, or isoluminant, for the neuron. To determine this isoluminant point, we fitted data from each neuron with a smooth curve by linearly interpolating between data points and convolving the interpolated curve with a Gaussian (s.d. = 2.3%). The red/green luminance contrast yielding the largest positive *DI* (the peak of this curve) was provisionally defined as the *neural isoluminant point*. For the neuron presented in Fig. 5, the neural isoluminant point was determined to be -7.46% luminance contrast (red brighter than green).

The neural isoluminant point was determined for 76/83 (92%) neurons that exhibited a single clear peak in their *DI* curve. Seven neurons in our sample exhibited two or more peaks in their *DI* curve, which prevented us from determining a single isoluminant point for these neurons. Excluding these neurons, the *mean neural isoluminant point* was calculated separately for each monkey. Means were determined to be -4.62% (Frisbee,  $n = 31$ ), -9.09% (Tutu,  $n = 31$ ), and -0.39% (Lefty,  $n = 14$ ) luminance contrast. Standard deviations (s.d.) of the means were  $\pm 3.5\%$  (Frisbee),  $\pm 2.9\%$  (Tutu), and  $\pm 4.9\%$  (Lefty). Single-factor ANOVA ( $\alpha = 0.05$ ) revealed that the differences in neural isoluminant points across the three monkeys were highly significant ( $P < 0.001$ ).

To estimate how MT neurons, as a population, might signal isoluminance, we used population-averaged *DI* data (Fig. 6). Such data represent the average or "pooled" response of MT neurons elicited by a red/green stimulus containing a given amount of luminance contrast. This pooled signal presumably arises further downstream in visual processing, within areas that receive convergent input from area MT. In turn, this signal is ultimately expected to govern the behavioral response, i.e. eye movements, in the case of our experiment. To estimate the pooled isoluminant signal arising from area MT, we determined the isoluminant point for the population-averaged data. Averaged *DI* data were fitted with a smooth curve and the red/green luminance contrast yielding the peak of the curve was provisionally defined as the *population neural isoluminant point*. This was performed separately for each animal. Population neural isoluminant points were determined to be -2.32% (Frisbee), -8.20% (Tutu), and -2.56% (Lefty) luminance contrast. These population values are fairly consistent with the *mean neural isoluminant points* determined for each monkey (see above).

### *Neural isoluminance as a function of eccentricity*

Receptive-field centers of our sampled MT neurons ranged from 3- to 14-deg eccentric to the center of gaze. This variation affords

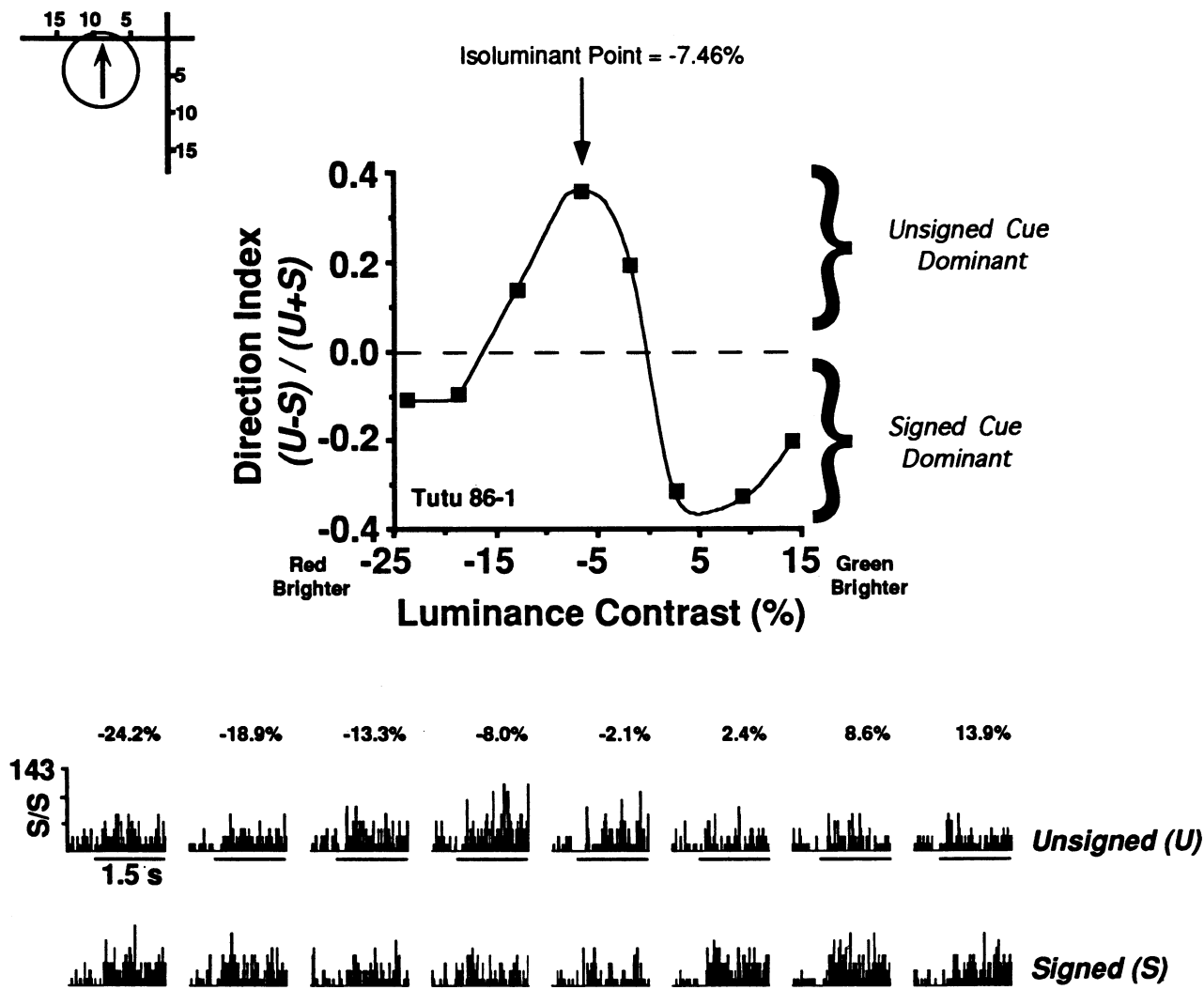

Fig. 5. Chromatic isoluminance determined for an individual area MT neuron. This neuron was stimulated with the moving contrast-reversed stimulus, depicted schematically in Fig. 3A (20-deg phase shift, 30 frames/s, 1.5 s). The neuron preferred upward motion and its receptive field was located in the lower contralateral quadrant, centered 9.85 deg eccentric to fixation (inset at upper left). It exhibited a direction index ( $DI$ ) of 0.79 when the stimulus consisted of a high-contrast luminance-defined bar. Luminance contrast between the red and green phases of the grating was varied across eight different levels ranging in equal (5.44%) intervals from  $-24.2\%$  to  $+13.9\%$ . Cumulative peristimulus histograms obtained in response to movement of the unsigned ( $U$ ) or signed ( $S$ ) cue moving in the neuron's preferred direction are shown at bottom for each red/green luminance contrast level tested ( $S/S = \text{spikes/s}$ ). Direction indices [ $DI = (U - S)/(U + S)$ ], computed from responses elicited by motion of unsigned ( $U$ ) and signed ( $S$ ) cues, are plotted (top center) as a function of luminance contrast. For a small range of luminance contrast levels near photometric isoluminance,  $DI$ s were positive, suggesting that the neuron was more sensitive to motion in the unsigned direction (Fig. 3A, solid arrow). By contrast, when sufficient luminance contrast was present in the stimulus,  $DI$ s became negative, suggesting that the neuron was more sensitive to motion in the signed direction (Fig. 3A, dashed arrow). A smooth curve was fitted to these data and the red/green luminance contrast yielding the largest positive  $DI$  (i.e. the peak in the curve) was provisionally defined as the *neural* isoluminant point, which was determined to be  $-7.46\%$  for this neuron. (After Dobkins & Albright, 1994).

us the opportunity to investigate whether the relative sensitivity for different wavelengths varies as a function of eccentricity, a topic that has been addressed by several human psychophysical investigations. For example, it has been shown that differential macular pigment density across the retina can alter psychophysical assessments of chromatic isoluminance. This appears to be restricted, however, to the S cone mechanism, leaving the relative sensitivities of the M and L cones unaltered (Wooten et al., 1975; Stabell & Stabell, 1980, 1981; Viénot, 1980).

Other investigators have attempted to determine whether spa-

tial variations in cone ratios vary with eccentricity. Few studies have addressed this question directly, primarily due to difficulties associated with distinguishing L from M cones. Some evidence does indicate, however, that L/M cone ratios remain fairly constant out to 40 deg (Marc & Sperling, 1977). Similar conclusions have been drawn using hue discrimination techniques to estimate L/M cone ratios in humans (Nerger & Cicerone, 1992). Despite the evidence for constant relative contributions of M and L cones across the retina, however, several laboratories have demonstrated that red/green isoluminance settings for

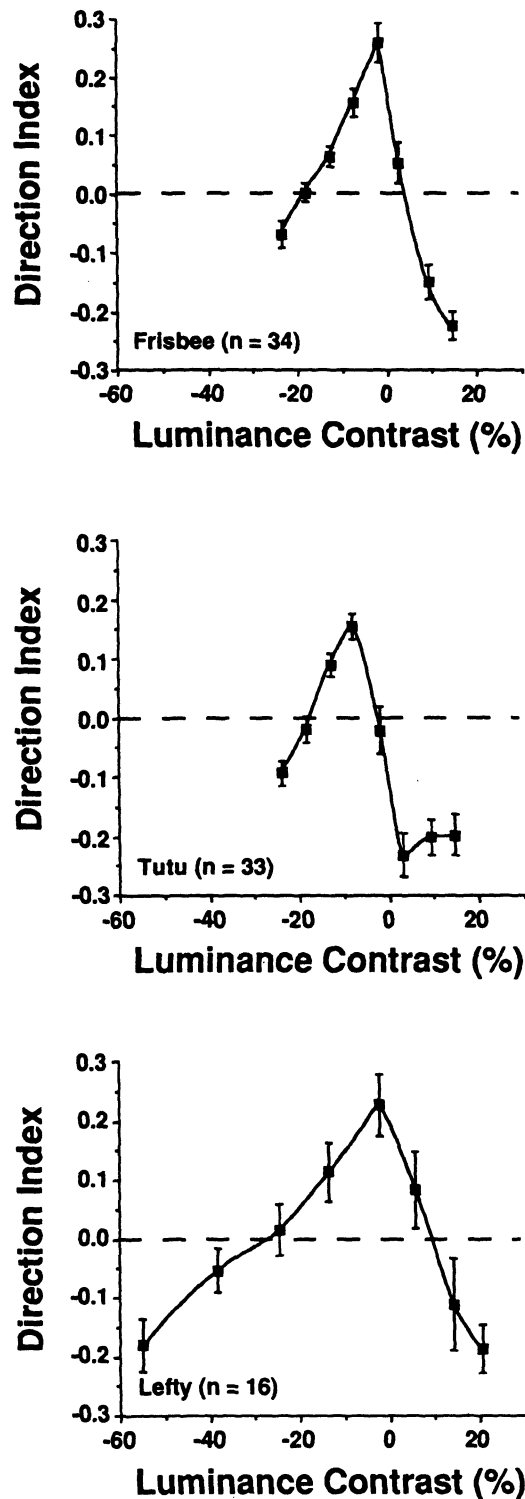

Fig. 6. Indices of directional selectivity averaged across MT neurons presented with chromatic contrast-reversed stimuli. Average *DI* is plotted as a function of red/green luminance contrast for each of three monkeys. Error bars denote standard errors of the means. Population data for each of the three monkeys exhibited inverted U-shaped curves with significant positive and significant negative *DIs*. Averaged *DI* data were fitted with a smooth curve and the red/green luminance contrast yielding the peak of the curve was provisionally defined as the *population* neural isoluminant point for each animal. These values were determined to be  $-2.32\%$  (Frisbee),  $-8.20\%$  (Tutu), and  $-2.56\%$  (Lefty) luminance contrast. (Data replotted from Dobkins & Albright, 1994).

human subjects vary as a function of eccentricity (e.g. Livingstone & Hubel, 1987; Mullen, 1991), a phenomenon that is potentially due to rod contribution to spectral sensitivity for eccentric stimuli (Mullen, 1991).

In contrast to the attention given this subject in psychophysical experiments, little effort has been aimed at determining the relationship between eccentricity and the relative effectiveness of red and green lights for individual neurons at various stages of the primate visual system. To investigate this relationship for individual MT neurons, we examined neural isoluminant points as a function of receptive-field center eccentricity. Data from three monkeys are shown in Fig. 7. Correlation ( $r^2$ ) values were determined to be 0.014 (Frisbee), 0.044 (Tutu), and 0.107 (Lefty), none of which were significant. The lack of any reliable correlation between neural isoluminance and eccentricity in these plots suggests that, for the eccentricities encountered in our experiments (3–14 deg), distribution of neural isoluminant points varied randomly across the retina. While this lack of an eccentricity effect appears to contradict results obtained from human psychophysical experiments, the difference may be due to the use of different stimulus conditions and/or methods of measurement between studies.

#### *Behavioral isoluminance: comparison to neurophysiological data*

Oculomotor data obtained from two monkeys are summarized in Fig. 8 (open circles). We were unable to elicit reliable tracking eye movements from our third monkey (Frisbee); following extinction of the fixation spot, she either continued to fixate or made a saccadic eye movement. Her data have therefore been excluded from this analysis. For each of the eight red/green

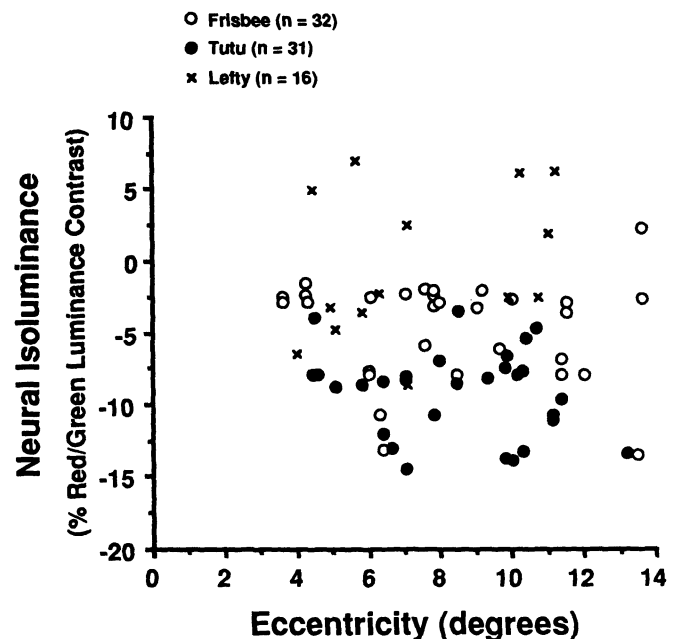
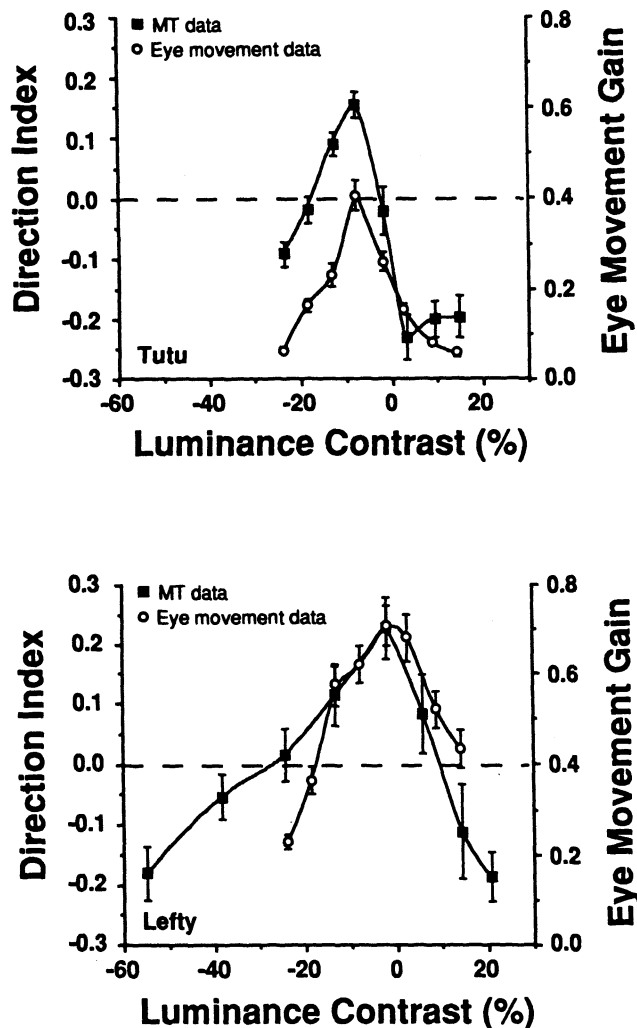

Fig. 7. Neural isoluminant points as a function of receptive-field eccentricity for three monkeys. Correlation ( $r^2$ ) values were determined to be 0.014 (Frisbee), 0.044 (Tutu), and 0.107 (Lefty), demonstrating that, with respect to the eccentricities encountered in our experiments (3–14 deg), neural isoluminance does not vary systematically with eccentricity.





**Fig. 8.** Behavioral (oculomotor) measures of chromatic isoluminance compared with population-averaged MT data for two monkeys. Eye-movement gain is plotted for a range of red/green luminance contrast values (open circles). Each data point represents the mean of 40 (Tutu) and 25 (Lefty) trials. Error bars indicate standard errors of the means. Data were fitted with a smooth curve and the red/green luminance contrast yielding the largest gain (the peak of the curve) was taken as an estimate of behavioral isoluminance for each animal (Tutu =  $-7.87\%$ , Lefty =  $-1.98\%$ ). To facilitate comparison with data obtained from area MT, population-averaged neuronal data (filled squares) have been replotted (from Fig. 6) on top of the eye-movement data. Although the metric are different for the neural and behavioral data, the two sets of data peak at nearly identical luminance contrasts and the shapes of both functions are very similar. These data demonstrate a striking correspondence between measures of isoluminance derived from eye movements and neuronal activity in area MT.

luminance contrast levels tested, data points represent the average eye-movement gain obtained over 40 (Tutu) or 25 (Lefty) trials. Each set of data was fitted with a smooth curve (as for neurophysiological data, described above) and the red/green luminance contrast yielding the largest eye-movement gain (the peak of the curve) was taken as a behavioral estimate of isoluminance for that animal under these specific stimulus conditions. For both monkeys, the behavioral isoluminant point determined

in this fashion (Tutu =  $-7.87\%$ , Lefty =  $-1.98\%$ ) corresponded extremely well with the population isoluminant point for MT neurons (Tutu =  $-8.20\%$ , Lefty =  $-2.56\%$ ). Behavioral isoluminant points also corresponded well with the mean isoluminant point across MT neurons (Tutu =  $-9.09\%$ , Lefty =  $-0.39\%$ ), although not quite as closely.

To facilitate comparison, population-averaged neuronal data (reproduced from Fig. 6) have been plotted with the eye-movement data. Although the metric are different for the neural and behavioral data, the two sets of data peak at nearly identical luminance contrasts and the shapes of both functions are quite similar. Note that this concordance between the oculomotor and neuronal measures exists despite differences in size and position of stimuli in the two conditions: a large stimulus field (22 deg) centered at the fovea was used to evoke eye movements and a smaller (10 deg) stimulus centered at varying places on the paracentral retina was used during neuronal recording (average receptive-field center eccentricity: Lefty = 7.0 deg, Tutu = 8.2 deg).

## Discussion

The results from these experiments demonstrate a tight correlation, within individual monkeys, between neural isoluminance obtained from MT neurons and a measure of behavioral isoluminance obtained from oculomotor responses. Although we can not rule out a potential contribution from cortical areas other than MT (e.g. those within the ventral cortical stream), our results provide evidence that activity within the dorsal/magnocellular stream is *sufficient* to account for the perceptual phenomenon of isoluminance. Because our behavioral measure of isoluminance involved tracking eye movements, the proposal for a relationship between neural activity in MT and perceptual isoluminance necessarily rests on the paired assumptions that oculomotor tracking is (1) correlated with perceptual judgments of isoluminance, and (2) a manifestation of activity within the dorsal/magnocellular stream. These topics will be addressed in the following sections.

### *Do oculomotor responses reflect perception?*

The results from several experiments have demonstrated that perceptual judgments of isoluminance for moving patterns are tightly correlated with oculomotor responses. For example, employing an oculomotor paradigm nearly identical to that used in our experiments, save the use of random dot stimuli rather than sinusoidal gratings, Chaudhuri and Albright (1992) demonstrated that the oculomotor responses of human subjects mirrored their judgments of direction of motion at all luminance ratios tested. More specifically, chromatic isoluminant points determined from oculomotor responses were identical to those obtained from perceptual reports. Logothetis and Charles (1990) have also provided evidence for a correlation between eye movements and perception in a study that employed the "minimum motion technique" (Anstis & Cavanagh, 1983; Cavanagh et al., 1987) to determine isoluminance points in monkeys. This method produces a reversal in the perceived direction of motion at the point of psychophysical isoluminance. Logothetis and Charles found that isoluminant points determined using perceptual responses of monkeys trained to discriminate direction of motion in this "minimum motion" stimulus were identical to isoluminant points determined using nystagmic eye movement responses. In

light of the results from these prior experiments, it is reasonable to infer that, with regard to isoluminance, the eye movements exhibited by our monkeys are a good indicant of their perceptual experience.

#### *MT contribution to eye movements*

The purpose of oculomotor tracking is to stabilize the image of a moving target with respect to the retina. To achieve this goal, visual inputs to the oculomotor system must carry information about direction and speed of target motion. In addition to circumstantial indications given by the fine motion sensitivity of MT neurons (Maunsell & Van Essen, 1983a; Albright, 1984), there are several lines of evidence that implicate this cortical area as a source of motion signals for oculomotor tracking. Neuroanatomical experiments have shown that area MT and surrounding occipito-parietal (presumed magnocellular stream) areas give rise to substantial projections to the dorso-lateral pons (Glickstein et al., 1980; Maunsell & Van Essen, 1983b; Ungerleider & Desimone, 1986)—a brain-stem region known to be involved in oculomotor pursuit (Mustari et al., 1988; May et al., 1988; Suzuki et al., 1990). Neurophysiological studies also support a contribution from MT and surrounding cortices. Lisberger and Westbrook (1985) noted similarities between visual stimulus parameters that influence smooth pursuit and those that affect the responsiveness of MT neurons. Similarly, Movshon and Lisberger (1990) reported correlations between temporal properties of pursuit and neuronal responses in MT. Although individual MT neurons do not seem to express pursuit-related motor activity (as manifested, for example, by neuronal activity during smooth pursuit without retinal slip), there are subpopulations of neurons in adjacent area MST that do behave in such a manner (Sakata et al., 1983; Komatsu & Wurtz, 1988a,b; Newsome et al., 1988). Area MST is a major recipient of projections from area MT (Maunsell & Van Essen, 1983b; Ungerleider & Desimone, 1986). Finally, disruption of normal activity in area MT, effected by either ablation (Newsome et al., 1985) or electrical microstimulation (Komatsu & Wurtz, 1989), causes a marked impairment of smooth pursuit, particularly during the open-loop phase. Thus, the presumed contribution of area MT to oculomotor tracking is supported by a considerable volume of evidence from neuroanatomical, neurophysiological, and ablation studies.

#### *Variability of neuronally determined isoluminant points: comparison of distributions across studies*

In our neurophysiological experiments, isoluminant points were found to vary across the population of MT neurons within an individual monkey. This "smear" of isoluminant points mirrors that observed at earlier stages of the motion pathway; for M retinal ganglion cells (Lee et al., 1988, 1993) and magnocellular LGN neurons (Schiller & Colby, 1983; Derrington et al., 1984; Logothetis et al., 1990). For example, Schiller and Colby (1983) and Logothetis et al. (1990) measured the responses of magnocellular and parvocellular LGN neurons elicited by red/green alternating lights. For each neuron tested, the red/green luminance ratio yielding equal or balanced responses was defined as the neuron's "balance point," which by our convention is the neural isoluminant point. Using data presented by Logothetis et al., we estimated that the standard deviation (s.d.) of the mean balance point across a population of 41 magnocellular LGN neu-

rons was  $\pm 16.3\%$  luminance contrast (c.f. Fig. 4, Logothetis et al., 1990). For our sampled MT neurons, standard deviations of the mean isoluminant points were  $\pm 3.5\%$  (Frisbee),  $\pm 2.9\%$  (Tutu), and  $\pm 4.9\%$  (Lefty). Saito et al. (1989) and Gegenfurtner et al. (1994) also reported the distribution of isoluminant points across MT neurons. Using the data of Saito et al. (c.f. Fig. 10, Saito et al., 1989), we estimate s.d. values of  $\pm 3.8\%$  ("small stimulus condition") and  $\pm 8.0\%$  ("large stimulus condition"). For the data of Gegenfurtner et al. (c.f. Fig. 6, Gegenfurtner et al., 1994), we calculate a s.d. of  $\pm 6.9\%$ . These values, obtained from two other studies, are only slightly higher than those we observed. Averaging across studies, it appears that the scatter of isoluminant points in MT is approximately a factor of three smaller than that observed at the level of the LGN, a phenomenon that can potentially be explained by a process in MT that pools or averages the signals arising from lower level inputs (e.g. Sclar et al., 1990).

#### *Inter-subject variability of chromatic isoluminance: the importance of conducting within-animal comparisons of neural and behavioral data*

In addition to the variability we observed across MT neurons within an individual animal, we also found that isoluminant points (both neural and behavioral) differed across our three monkeys as well as from human V $\lambda$  isoluminance. Indeed, the existence of inter-subject variability may explain the fact that neurally defined isoluminant points in monkeys are often discrepant with those derived from human psychophysical experiments conducted under different stimulus conditions. An example of this can be found by comparing the neurophysiological results of Schiller and Colby (1983) and Logothetis et al., (1990) with standard psychophysical measures of isoluminance in humans, i.e. V $\lambda$  isoluminance. Although not the main focus of these experiments, the mean of the balance point distribution for magnocellular neurons was close to, but not in direct agreement, with human V $\lambda$  isoluminance (c.f. Fig. 4, Logothetis et al., 1990; Fig. 5, Schiller & Colby, 1983).

In sum, the existence of variability in chromatic isoluminant points across individuals emphasizes the importance of conducting within-animal comparisons of neural and behavioral data. Furthermore, since stimulus parameters (such as spatial and temporal frequency, and possibly eccentricity) and method of measurement can also influence estimates of chromatic isoluminance, the stimulus conditions used for obtaining neural and behavioral estimates should resemble one another as closely as possible. Only under such conditions can we draw reliable inferences regarding correlations between neural and behavioral effects of chromatic isoluminance.

#### **Acknowledgments**

This work was supported by NIH Grant EY07605, a McKnight Neuroscience Development Award (T.D.A.), and a Fight-For-Sight Summer Fellowship (K.R.D.). We thank J. Costanza for superb technical assistance. We are also grateful to K. Gegenfurtner for insightful comments on the manuscript and to J. Palmer and D. MacLeod for helpful discussions.

#### **References**

- ALBRIGHT, T.D. (1984). Direction and orientation selectivity of neurons in visual area MT of the macaque. *Journal of Neurophysiology* **52**, 1106–1130.

- ANSTIS, S.M. (1970). Phi movement as a subtractive process. *Vision Research* **10**, 1411-1430.
- ANSTIS, S.M. & CAVANAGH, P. (1983). A minimum motion technique for judging equiluminance. In *Colour Vision: Physiology and Psychophysics*, ed. MOLLON, J.D. & SHARPE L.T., pp. 156-166. London: Academic.
- ANSTIS, S. & MATHER, G. (1985). Effects of luminance and contrast on direction of ambiguous apparent motion. *Perception* **14**, 167-179.
- BOYNTON, R.M. (1986). A system of photometry and colorimetry based on cone excitations. *COLOR Research and Application* **11**, 244-252.
- CAVANAGH, P. & ANSTIS, S.M. (1991). The contribution of color to motion in normal and color-deficient observers. *Vision Research* **31**, 2109-2148.
- CAVANAGH, P., MACLEOD, D.I.A. & ANSTIS, S.M. (1987). Equiluminance: Spatial and temporal factors and the contribution of blue-sensitive cones. *Journal of the Optical Society of America* **4**, 1428-1438.
- CAVANAGH, P., TYLER, C.W. & FAVREAU, O.E. (1984). Perceived velocity of moving chromatic gratings. *Journal of the Optical Society of America* **1**, 893-899.
- CHARLES, E.R. & LOGOTHETIS, N.K. (1989). The responses of middle temporal (MT) neurons to isoluminant stimuli. *Investigative Ophthalmology and Visual Science* **30**, 427.
- CHAUDHURI, A. & ALBRIGHT, T.D. (1992). Heterochromatic fusion nystagmus: Its use in estimating chromatic equaluminance in humans and monkeys. *Vision Research* **32**, 1745-1759.
- CUSHMAN, W.B. & LEVINSON, J.Z. (1983). Phase shift in red and green counterphase flicker at high frequencies. *Journal of the Optical Society of America* **73**, 1557-1561.
- DERRINGTON, A.M., KRAUSKOPF, J. & LENNIE, P. (1984). Chromatic mechanisms in lateral geniculate nucleus of macaque. *Journal of Physiology* **357**, 241-265.
- DE VALOIS, R.L., MORGAN, H.C., POLSON, M., MEAD, W.R. & HULL, E. (1974). Psychophysical studies of monkey vision—I. Macaque luminosity and color vision tests. *Vision Research* **14**, 53-67.
- DOBKINS, K.R. & ALBRIGHT, T.D. (1990). Color facilitates motion correspondence in visual area MT. *Society for Neuroscience Abstracts* **16**, 1220.
- DOBKINS, K.R. & ALBRIGHT, T.D. (1993). What happens if it changes color when it moves? Psychophysical experiments on the nature of chromatic input to motion detectors. *Vision Research* **33**, 1019-1036.
- DOBKINS, K.R. & ALBRIGHT, T.D. (1994). What happens if it changes color when it moves? The nature of chromatic input to macaque visual area MT. *Journal of Neuroscience* **14**, 4854-4870.
- FLITCROFT, D.I. (1989). The interactions between chromatic aberration, defocus and stimulus chromaticity: Implications for visual physiology and colorimetry. *Vision Research* **29**, 349-360.
- GEGENFURTNER, K.R., KIPER, D.C., BEUSMANS, J.M.H., CARADINI, M., ZAIDI, Q. & MOVSHON, J.A. (1994). Chromatic properties of neurons in macaque MT. *Visual Neuroscience* **11**, 455-466.
- GLICKSTEIN, M., COHEN, J.L., DIXON, B., GIBSON, A., HOLLINS, M., LABOSSIER, E. & ROBINSON, F. (1980). Corticopontine visual projections in macaque monkeys. *Journal of Comparative Neurology* **190**, 209-229.
- HUBEL, D.H. & LIVINGSTONE, M.S. (1990). Color and contrast sensitivity in the lateral geniculate body and primary visual cortex of the macaque monkey. *Journal of Neuroscience* **10**, 2223-2237.
- JUDGE, S.J., RICHMOND, B.J. & CHU, F.C. (1980). Implantation of magnetic search coils for measurement of eye position: An improved method. *Vision Research* **20**, 535-538.
- KAISER, P.K., LEE, B.B., MARTIN, P.R. & VALBERG, A. (1990). The physiological basis of the minimally distinct border demonstrated in the ganglion cells of the macaque retina. *Journal of Physiology* **422**, 153-183.
- KELLY, D.H. (1983). Spatiotemporal variation of chromatic and achromatic contrast thresholds. *Journal of the Optical Society of America* **73**, 742-750.
- KOLERS, P.A. (1972). *Aspects of Motion Perception*. Oxford: Pergamon Press.
- KOMATSU, H. & WURTZ, R. H. (1988a). Relation of cortical area MT and MST to pursuit eye movements. I. Localization and visual properties of neurons. *Journal of Neurophysiology* **60**, 580-603.
- KOMATSU, H. & WURTZ, R. H. (1988b). Relation of cortical areas MT and MST to pursuit eye movements. III. Interaction with full-field visual stimulation. *Journal of Neurophysiology* **60**, 621-644.
- KOMATSU, H. & WURTZ, R. H. (1989). Modulation of pursuit eye movements by stimulation of cortical areas MT and MST. *Journal of Neurophysiology* **62**, 31-47.
- LEE, B.B., MARTIN, P.R. & VALBERG, A. (1988). The physiological basis of heterochromatic flicker photometry demonstrated in the ganglion cells of the macaque retina. *Journal of Physiology* **404**, 323-347.
- LEE, B.B., MARTIN, P.R., VALBERG, A. & KREMERS, J. (1993). Physiological mechanisms underlying psychophysical sensitivity to combined luminance and chromatic modulation. *Journal of the Optical Society of America A* **10**, 1403-1412.
- LISBERGER, S.G. & WESTBROOK, L.E. (1985). Properties of visual inputs that initiate horizontal smooth pursuit eye movements in monkeys. *Journal of Neuroscience* **5**, 1662-1673.
- LIVINGSTONE, M.S. & HUBEL, D.H. (1987). Psychophysical evidence for separate channels for the perception of form, color, movement and depth. *Journal of Neuroscience* **7**, 3416-3468.
- LOGOTHETIS, N.K. & CHARLES, E.R. (1990). The minimum motion technique applied to determine isoluminance is psychophysical experiments with monkeys. *Vision Research* **30**, 829-838.
- LOGOTHETIS, N.K., SCHILLER, P.H., CHARLES, E.R. & HURLBERT, A.C. (1990). Perceptual deficits and the activity of the color-opponent and broad-band pathways at isoluminance. *Science* **247**, 214-217.
- MACLEOD, D.I.A. & BOYNTON, R.M. (1979). Chromaticity diagram showing cone excitation by stimuli of equal luminance. *Journal of the Optical Society of America* **69**, 1183-1186.
- MARC, R.E. & SPERLING, H.G. (1977). Chromatic organization of primate cones. *Science* **196**, 454-456.
- MAUNSELL, J.H.R. & VAN ESSEN, D.C. (1983a). Functional properties of neurons in middle temporal visual area of the macaque monkey. I. Selectivity for stimulus direction, speed, and orientation. *Journal of Neurophysiology* **49**, 1127-1147.
- MAUNSELL, J.H.R. & VAN ESSEN, D.C. (1983b). The connections of the middle temporal visual area (MT) and their relationship to a cortical hierarchy in the macaque monkey. *Journal of Neuroscience* **3**, 2563-2586.
- MAY, J.G., KELLER, E.L. & SUZUKI, D.A. (1988). Smooth-pursuit eye movement deficits with chemical lesions in the dorsolateral pontine nucleus of the monkey. *Journal of Neurophysiology* **59**, 952-977.
- MIKAMI, A., NEWSOME, W.T. & WURTZ, R.H. (1986). Motion selectivity in macaque visual cortex. II. Spatiotemporal range of directional interactions in MT and VI. *Journal of Neurophysiology* **55**, 1328-1339.
- MOVSHON, J.A. & LISBERGER, S.G. (1990). Visual motion signals supportive pursuit eye movements. *Investigative Ophthalmology and Visual Science* **31**, 239.
- MULLEN, K.T. (1985). The contrast sensitivity of human colour vision to red-green and blue-yellow chromatic gratings. *Journal of Physiology (London)* **359**, 381-409.
- MULLEN, K.T. (1991). Colour vision as a post-receptorial specialization of the central visual field. *Vision Research* **31**, 119-130.
- MUSTARI, M.J., FUCHS, A.F. & WALLMAN, J. (1988). Response properties of dorsolateral pontine units during smooth pursuit in the rhesus macaque. *Journal of Neurophysiology* **60**, 664-86.
- NERGER, J.L. & CICERONE, C.M. (1992). The ratio of L cones to M cones in the human parafoveal retina. *Vision Research* **32**, 879-888.
- NEWSOME, W.T., WURTZ, R.H., DURTELER, M.R. & MIKAMI, A. (1985). Deficits in visual motion perception following ibotenic acid lesions of the middle temporal visual area of the macaque monkey. *Journal of Neuroscience* **5**, 825-840.
- NEWSOME, W.T., MIKAMI, A. & WURTZ, R.H. (1986). Motion selectivity in macaque visual cortex. III. Psychophysics and physiology of apparent motion. *Journal of Neurophysiology* **55**, 1340-1351.
- NEWSOME, W.T., WURTZ, R.H. & KOMATSU, H. (1988). Relation of cortical areas MT and MST to pursuit eye movements. II. Differentiation of retinal from extraretinal inputs. *Journal of Neurophysiology* **60**, 604-620.
- POKORNY, J. & SMITH, V.C. (1986). Colorimetry and color discrimination. In *Handbook of Perception and Human Performance*, ed. BOFF, K.R., KAUFMAN, L. & THOMAS, J.P., Chapter 8. New York: Wiley.
- POKORNY, J., SMITH, V.C. & LUTZE, M. (1989). Heterochromatic modulation photometry. *Journal of the Optical Society of America* **6**, 1618-1623.
- RAMACHANDRAN, V.S. & GREGORY, R.L. (1978). Does color provide an input to human motion detection? *Nature* **275**, 55-56.
- ROBINSON, D.A. (1963). A method of measuring eye movement using

- a scleral search coil in a magnetic field. *IEEE Transactions in Bio-medical Engineering* **10**, 137-145.
- ROBSON, J.G. (1966). Spatial and temporal contrast sensitivity functions of the visual system. *Journal of the Optical Society of America* **56**, 1141-1142.
- SAITO, H., TANAKA, K., ISONO, H., YASUDA, M. & MIKAMI, A. (1989). Directionally selective response of cells in the middle temporal area (MT) of the macaque monkey to the movement of equiluminous opponent color stimuli. *Experimental Brain Research* **75**, 1-14.
- SAKATA, H., SHIBUTANI, H. & KAWANO, K. (1983). Functional properties of visual tracking neurons in posterior parietal association cortex of the monkey. *Journal of Neurophysiology* **49**, 1364-1380.
- SCHILLER, P.H. & COLBY, C.L. (1983). The responses of single cells in the lateral geniculate nucleus of the rhesus monkey to color and luminance contrast. *Vision Research* **23**, 1631-1641.
- SCHILLER, P.H., LOGOTHETIS, N.K. & CHARLES, E.R. (1990). Functions of the colour-opponent and broad-band channels of the visual system. *Nature* **343**, 68.
- SLAR, G., MAUNSELL, J.H.R. & LENNIE, P. (1990). Coding of image contrast in the central visual pathway of the macaque monkey. *Vision Research* **30**, 1-10.
- SMITH, V.C. & POKORNY, J. (1972). Spectral sensitivity of color-blind observers and the cone photopigments. *Vision Research* **12**, 2059-2071.
- SMITH, V.C. & POKORNY, J. (1975). Spectral sensitivity of the foveal cone photopigments between 400 and 500 nm. *Vision Research* **15**, 161-171.
- STABELL, B. & STABELL, U. (1981). Absolute spectral sensitivity at different retinal eccentricities. *Journal of the Optical Society of America* **71**, 836-840.
- STABELL, U. & STABELL, B. (1980). Variation in density of macular pigmentation and in short-wave cone sensitivity with eccentricity. *Journal of the Optical Society of America* **70**, 706-711.
- SUZUKI, D.A., MAY, J.G., KELLER, E.L. & YEE, R.D. (1990). Visual motion properties of neurons in dorsolateral pontine nucleus of alert monkey. *Journal of Neurophysiology* **63**, 37-59.
- TELLER, D.Y. & LINDSEY, D.T. (1993). Motion at isoluminance: motion dead zones in three-dimensional color space. *Vision Research* **10**, 1324-1331.
- UNGERLEIDER, L.G. & DESIMONE, R. (1986). Cortical connections of visual area MT in the macaque. *Journal of Comparative Neurology* **248**, 190-222.
- VALBERG, A., LEE, B.B., KAISER, P.K. & KREMERS, J. (1992). Responses of macaque ganglion cells to movement of chromatic borders. *Journal of Physiology* **458**, 579-602.
- VIENOT, F. (1980). Relations between inter- and intra-individual variability of color-matching functions. Experimental results. *Journal of the Optical Society of America* **70**, 1476-1483.
- WATSON, A.B., NIELSON, K.R.K., POIRSON, A., FITZHUGH, A., BILSON, A., NGUYEN, K. & AHUMADA, A.J. (1986). Use of a faster frame-buffer in vision research. *Behavior Research Methods, Instruments and Computers* **18**, 587-594.
- WAGNER, G. & BOYNTON, R.M. (1972). Comparison of four methods of heterochromatic photometry. *Journal of the Optical Society of America* **62**, 1508-1515.
- WEBSTER, M.A. & MOLLON, J.D. (1993). Contrast adaptation dissociates different measures of luminance efficiency. *Journal of the Optical Society of America A* **10**, 1332-1340.
- WOOTEN, B.R., FULD, K. & SPILLMAN, L. (1975). Photopic spectral sensitivity of the peripheral retina. *Journal of the Optical Society of America* **65**, 334-342.
- ZEKI, S.M. (1974). Functional organization of a visual area in the posterior bank of the superior temporal sulcus of the rhesus monkey. *Journal of Physiology* **236**, 549-573.